

ATLANTIC SOFT CLOSE HINGE

530 Glass to glass for 10mm (3/8") - 12mm(1/2") glass

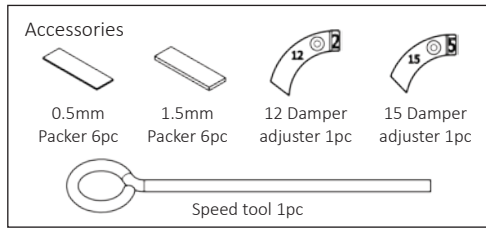

Installation

1. Check that the alignment of the glass hinge panel is plumb.



Watch the install video

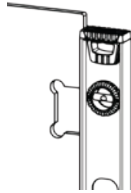

4. Open the top hinge and place packers below the hinge. Push them in level with the glass then rest the hinge on the packer. Repeat for the bottom hinge. Make sure the hinges are plumb. Then tighten the cover plate screws on the hinge panel side.

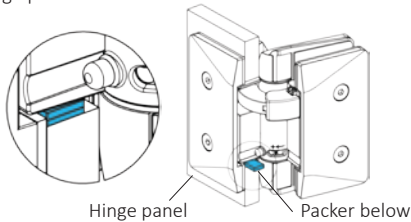

2. Undo the cover plate screws completely, then screw them back in 2 to 3 turns. For 12mm (1/2") panel, remove the rear spacer from the corresponding side. For 10mm (3/8") panel leave the rear spacer in.

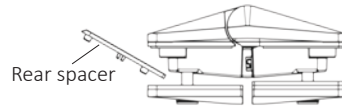

5. Place the gate panel on timber blocks to bring it close to level with the other panels. Then slide the gate panel into the hinges. Position the gate panel with the latch side 2mm higher. Then tighten the cover plate screws.

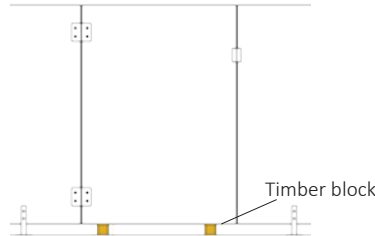

3. Take one hinge and slide the D plate side into the top cut out of the hinge panel. Lightly tighten the cover plate screws. The hinge should still be movable in the cut out. Repeat these steps for the other hinge in the bottom cut out.

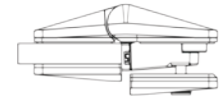

6. Open the gate and on the gate panel side, insert the packers above the hinge for both top and bottom hinges. Push packers in level with the glass, then carefully test the gate and make sure it opens freely.

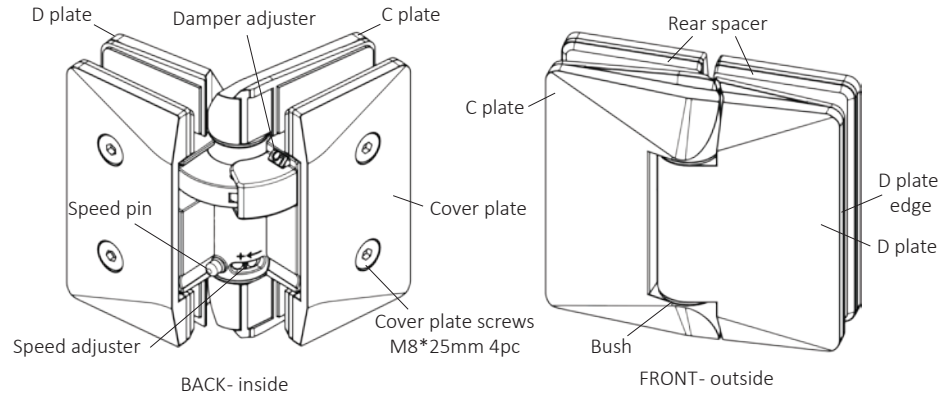
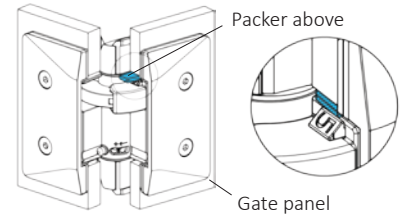



Watch the install video

530 Glass to glass for 10mm (3/8") - 12mm(1/2') glass

NOTE: Speed or damper adjustments should only be done after the hinges are installed.

In most cases, the hinges will not need any adjustment.

WATCH VIDEO atlantichinge.com/install

Increasing speed

1. Insert the speed tool all the way into the speed adjuster at the base of the arrow.

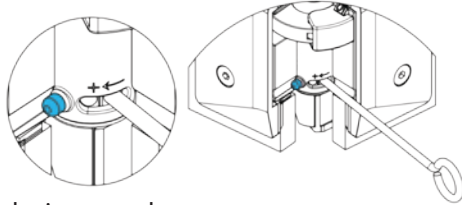

2. Apply pressure on the speed tool in the + symble direction until you can remove the speed pin. Then push the tool to the + symble to increase speed.

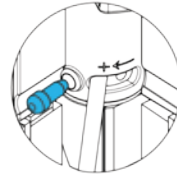

3. Insert the speed pin all the way back in, release the pressure of the speed tool and remove it.

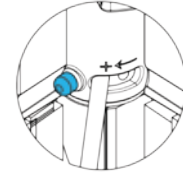

Reducing speed

1. Insert the speed tool all the way into the speed adjuster at the + symbol.

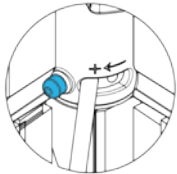

2. Apply pressure in the + direction on the speed tool until you can remove the speed pin. Then allow the tool to rotate to the base of the arrow to reduce speed.

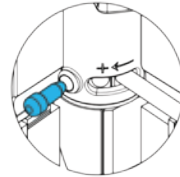

3. Insert the speed pin all the way back in, release the pressure of the speed tool and remove it.

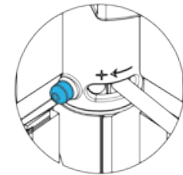

Damper adjustment

Damper adjusters are numbered. The larger the number, the more damping. 15 is the highest and 12 is the lowest.

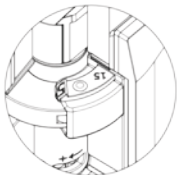

1. Open the gate and slide out the damper adjuster.

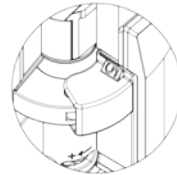

2. Insert the damper adjuster. Push in all the way.

TROUBLESHOOTING CHECKLIST

Squeak Noise - Check the spigots as they can cause this noise in some circumstances.

Door closing slowly - Check hinge panel alignment and speed adjustment and damper adjustment. if the problem persists, please contact Atlantic Hinge.

Door slamming - Check damper adjustment and reduce closing speed. If the problem persists, please contact Atlantic Hinge.